

THIS REPORT HAS BEEN DELIMITED  
AND CLEARED FOR PUBLIC RELEASE  
UNDER DOD DIRECTIVE 5200.20 AND  
NO RESTRICTIONS ARE IMPOSED UPON  
ITS USE AND DISCLOSURE.

DISTRIBUTION STATEMENT A

APPROVED FOR PUBLIC RELEASE;  
DISTRIBUTION UNLIMITED.

# **E X C L U D E D**

**FROM GENERAL CLASSIFICATION SCHEDULE  
IN ACCORDANCE WITH  
INFORMATION SECURITY PROGRAM REGULATION**

**DATED - JULY 1972**

**DDG 5000.1R & EXECUTIVE ORDER 11652  
(EXECUTIVE ORDER 10501 AMENDED)**

**BY**

**Defense Documentation Center  
Defense Supply Agency  
Cameron Station  
Alexandria, Virginia 22314**

**DEC 1972**

UNCLASSIFIED

AD. 44 780

CLASSIFICATION CHANGED

TO: UNCLASSIFIED

FROM: CONFIDENTIAL

AUTHORITY:

USAEC Ltr, 16 Jun 80

---



UNCLASSIFIED

# Armed Services Technical Information Agency

Because of our limited supply, you are requested to return this copy WHEN IT HAS SERVED YOUR PURPOSE so that it may be made available to other requesters. Your cooperation will be appreciated.

**AD**

**44780**

NOTICE: WHEN GOVERNMENT OR OTHER DRAWINGS, SPECIFICATIONS OR OTHER DATA ARE USED FOR ANY PURPOSE OTHER THAN IN CONNECTION WITH A DEFINITELY RELATED GOVERNMENT PROCUREMENT OPERATION, THE U. S. GOVERNMENT THEREBY INCURS NO RESPONSIBILITY, NOR ANY OBLIGATION WHATSOEVER; AND THE FACT THAT THE GOVERNMENT MAY HAVE FORMULATED, FURNISHED, OR IN ANY WAY SUPPLIED THE SAID DRAWINGS, SPECIFICATIONS, OR OTHER DATA IS NOT TO BE REGARDED BY IMPLICATION OR OTHERWISE AS IN ANY MANNER LICENSING THE HOLDER OR ANY OTHER PERSON OR CORPORATION, OR CONVEYING ANY RIGHTS OR PERMISSION TO MANUFACTURE, USE OR SELL ANY PATENTED INVENTION THAT MAY IN ANY WAY BE RELATED THERETO.

Reproduced by

**DOCUMENT SERVICE CENTER**

**KNOTT BUILDING, DAYTON 2, OHIO**

AD NO. 44780  
SEE / TASTMA FILE COPY

TECHNICAL MEMORANDUM-1572  
 PRELIMINARY EVALUATION  
 OF A MINIATURE PORTABLE  
 WIRE RECORDER  
 FOR  
 COUNTERMEASURES APPLICATIONS  
 AS OF  
 1 MARCH 1954



PROPERTY OF  
 OASD (R&D)  
 TECHNICAL LIBRARY

Signal Corps Proj. Nr. 1119A

D.A. Proj. Nr. 330-02-191

SIGNAL CORPS ENGINEERING LABORATORIES

FORT MONMOUTH, N. J.

OCT 11 1954

SEE SC FORM NO. 219  
 FEB. 23 AUG. 1946  
 Army Ft. Monmouth, NJ--ACN 853-34

**NOTICE: THIS DOCUMENT CONTAINS INFORMATION AFFECTING THE  
NATIONAL DEFENSE OF THE UNITED STATES WITHIN THE MEANING  
OF THE ESPIONAGE LAWS, TITLE 18, U.S.C., SECTIONS 793 and 794.  
THE TRANSMISSION OR THE REVELATION OF ITS CONTENTS IN  
ANY MANNER TO AN UNAUTHORIZED PERSON IS PROHIBITED BY LAW.**

CONFIDENTIAL

PRELIMINARY EVALUATION OF A MINIATURE  
PORTABLE WIRE RECORDER  
FOR COUNTERMEASURES APPLICATIONS

by

COSIMO TESTA

1 March 1954

as of

3 June 1954

Official: Samuel Stiber  
SAMUEL STIBER  
Chief, Equipment Branch  
Countermeasures Division, ESL

TM-1572

Copy Nr.

Signal Corps Proj. Nr. 1119A  
Dept. of the Army Proj. Nr. 330-02-191

HEADQUARTERS, SIGNAL CORPS ENGINEERING LABORATORIES  
FORT MONMOUTH, NEW JERSEY

CONFIDENTIAL  
54A A

64443

C O N F I D E N T I A L

This document contains information affecting the national defense of the United States within the meaning of the Espionage Laws, Title 18 U.S.C., sections 793 and 794. The transmission or the revelation of its contents in any manner to an unauthorized person is prohibited by law.

C O N F I D E N T I A L



C O N F I D E N T I A L

PRELIMINARY EVALUATION OF A MINIATURE  
PORTABLE WIRE RECORDER  
FOR COUNTERMEASURES APPLICATIONS

TABLE OF CONTENTS

TEXT	PAGE
1. Foreword	i
2. Purpose	1
3. Summary	1
4. Discussion	1
a. Description of the Minifon Wire Recorder	i
b. Performance Characteristics of the Minifon	6
5. Conclusions	11
6. Recommendations	12
7. Acknowledgment	12
8. References	13
 <b>APPENDIX</b>	
EXHIBIT I	MINIFON WIRE RECORDER. Display view, showing complete unit assembled (Photograph No. SCEL-39283).
EXHIBIT II	MINIFON WIRE RECORDER. Group view, record assembly showing microphone plug inserted for recording and power unit inserted for AC operation of motor. (Photograph No. SCEL 39281).
EXHIBIT III	MINIFON WIRE RECORDER. Group view, playback assembly showing Head-Set Plug inserted for playback operation, also zipper carrying case. (Photograph No. SCEL 39282).
EXHIBIT IV	MINIFON WIRE RECORDER. Overall view, recording operation showing unit in carrying case, cover removed, with microphone inserted ready for recording. (Photograph No. SCEL 39288).
EXHIBIT V	MINIFON WIRE RECORDER. Close-up top view, wire feed mechanism showing construction details. (Photograph No. SCEL 39289).
EXHIBIT VI	MINIFON WIRE RECORDER. Close-up bottom view, wire feed mechanism showing construction details. (Photograph No. SCEL 39296).

C O N F I D E N T I A L

C O N F I D E N T I A L

TABLE OF CONTENTS (Contd.)

- EXHIBIT VII MINIFON WIRE RECORDER. Overall view, showing plastic case, cover removed, with amplifier and batteries in place. (Photograph No. SCEL 39286).
- EXHIBIT VIII MINIFON WIRE RECORDER. Close-up bottom view, amplifier strip, showing wiring and component arrangement. (Photograph No. SCEL 39285).
- EXHIBIT IX MINIFON WIRE RECORDER. Close-up top view, amplifier strip, showing tubes, volume control, output transformer and record-playback transfer switch. (Photograph No. SCEL 39284).
- EXHIBIT X MINIFON WIRE RECORDER. Overall view, showing plastic case with amplifier and wire transport mechanism removed and showing shielding and batteries in place. (Photograph No. SCEL 39287).
- EXHIBIT XI MINIFON WIRE RECORDER. Group view, AC power supply for motor drive, showing step-down transformer, selenium rectifier and cover. (Photograph No. SCEL 39291).
- EXHIBIT XII CIRCUIT DIAGRAM OF MINIFON WIRE RECORDER
- EXHIBIT XIII GAIN VS FREQUENCY. Response curves of the Minifon Wire Recorder.

C O N F I D E N T I A L

# CONFIDENTIAL

## PRELIMINARY EVALUATION OF A MINIATURE PORTABLE WIRE RECORDER FOR COUNTERMEASURES APPLICATIONS

### 1. FOREWORD:

Post World War II developments in the field of magnetic tape, wire and paper recordings have resulted in the production of improved, compact, and versatile equipments of this nature. The requirements imposed upon these recorders are manifold, the important being high frequency response, compactness and simplicity of construction, simplicity of operation, and maximum economy of recording medium employed. The outstanding feature of recording information on a permanent basis is that it enables the recorders to store electrical data for future analysis and playback.

Because of its small size, weight and portability, one miniature wire recorder, the Minifon, was selected by this Laboratory for analysis and evaluation towards possible usage in countermeasures military electronic applications. The Minifon wire recorder employs sub-miniature components and is presently being manufactured in Germany. The following report deals with a discussion and description of the characteristics of the Minifon.

### 2. PURPOSE:

The purpose of this report is twofold:

- a. It is a preliminary description and evaluation of the mechanical and electrical characteristics of the Minifon recorder.
- b. It is a preliminary evaluation of the applicability of the Minifon in recording signals from electronic countermeasures reconnaissance equipments.

### 3. SUMMARY:

The Minifon wire recorder does not represent a particular advancement in the field of wire recording as such, particularly where high frequency response is required, due to the small size of the unit. However, because of its size, weight, portability and versatility, the Minifon offers many possibilities of applications where such physical characteristics are required. Therefore, it was decided to study the recorder in detail to evaluate its possible usage for the permanent recording of electrical data obtained from small lightweight, countermeasure radio receiving equipments. (Such data as antenna scan rates and pulse recurrence frequency of radar systems could be recorded.)

### 4. DISCUSSION:

#### a. Description of the Minifon Wire Recorder

The Minifon is a small, portable, completely self-contained, battery

## C O N F I D E N T I A L

operated wire recorder. The unit weighs approximately two pounds seven ounces and measures 1-3/8 inches thick, 4-3/8 inches wide and 6-5/8 inches long. Additional equipment, used with the recorder, comprises a small lightweight microphone, a stethoscope type set of earphones, wire spool and a transformer power supply for operating the motor from 117 volts A.C.

The Minifon provides a continuous playing time from 1/2 hour to 2-1/2 hours depending on the wire content of the supply spool.

The recording unit is enclosed in a light plastic case with all operating controls easily accessible to the user. These controls consist of a plug in receptacle, located on the top edge of the case, which will accommodate either the microphone or earphones; a small volume control located at the top left corner and a forward rewind control (transfer switch) located at the left center edge of the case. The erase and running indicator facilities are located on the upper left and right sections of the cover. The main "on-off" switch is located on the top right edge of the case. A receptacle is provided on the bottom right edge for plugging in an external power supply for 117 volts A.C. operation (motor only).

The cover is easily removed by turning a small locking device which is located on the lower part of the cover. A simulated leather, zippered carrying case is provided for use with the recorder. All operating controls are accessible to the operator when the unit is installed in the carrying case and the equipment is normally operated in this manner. (Note EXHIBITS I, II, III, IV).

The following is a detailed description of the major components of the Minifon:

- (1) **Wire Transport System:** The wire feed, recording and "take up" mechanism is small, well designed and consists primarily of the following sub-components:
  - (a) **Wire (Supply) Spool:** This spool contains the recording wire. It serves as a storage cell and is used to supply wire to the recording head. The spool has a flange diameter of 1-3/4 inches and a hub diameter of 1-1/8 inches. The spool has a total wire capacity providing for a maximum of 2-1/2 hours of continuous recording. The diameter of the wire is .002 inch. One side of this reel is coded in black and white sections, enabling its direction of rotation to be observed through a small circular window on the case cover. During rewind, the reel turns in a clockwise direction. During "record" or "playback", the direction of rotation is counterclockwise. (See EXHIBIT V).
  - (b) **Take-up Spool:** This reel is used to take-up and store the wire during the recording cycle. It has a flange diameter of 3-1/8 inches and a hub diameter of 2-3/4 inches.

C O N F I D E N T I A L

- (c) *Recording Head:* This unit contains a single recording head, measuring approximately 1 inch in diameter and 1/2 inch thick. In operation the recording head is moved with an up and down motion by a mechanical arm arrangement which results in smooth, uniform wire distribution on both the take-up and wire feed spools. The recording head is also used to pick-up signal information from the wire in playback operation. (See EXHIBITS V, VI).
  - (d) *Erase Mechanism:* A permanent magnet is used to remove the recorded information from the wire. The magnet is located alongside the recording wire between the recording head and the take-up reel. During recording operations the magnet is pivoted aside, away from the wire, by a small arm extending through the case cover. For erasure, the magnet is pivoted towards the recording head to engage the wire. Erasure is accomplished during the rewind cycle. (Note EXHIBIT V).
  - (e) *Motor:* A miniature, 9 volt D. C., permanent magnet motor, measuring approximately 3/4 inch in diameter by 1-1/2 inches long, is used to drive the wire transport mechanism. An electrical mechanical governor and hash filter combination are incorporated to regulate the motor speed. (Note EXHIBIT VI).
  - (f) *Forward Rewind (Transfer Switch):* This switch comprises a lever which controls the engagement of the proper gears for either forward (record or playback operations) or reverse (rewind cycle) motions of the take-up and wire spools. Braking facilities are included to prevent wire breakage. The rate of wire speed is also affected by this switch. During rewind the wire speed is approximately twice that of the recording rate. (Note EXHIBITS V, VI).
- (2) *Amplifier Section:* The record-reproduce amplifier employs a normal audio circuit using sub-miniature components and is constructed on a strip measuring approximately 5/8 inch thick, by 4 inches long, by 2 inches wide. All of the components are permanently soldered through eyelets on the strip. The major elements of the amplifier assembly are as follows: (See EXHIBITS VIII, IX).
- (a) *Tube Complement:* Three sub-miniature pentode tubes are used in the amplifier circuit, two Philips type DF-67 and one Philips type DL-67. Tube DF-67 has a filament current drain of 13.3 milliamperes at .625 volts. Tube DL-67 has a filament drain of 13.3 milliamperes at 1.25 volts. The nearest American equivalent to these tubes are types CK549-DX and CX548-DX, respectively. (See EXHIBIT IX).

## CONFIDENTIAL

- (b) *Record-Playback Switch*: A unique switching device is incorporated into the recorder circuit and partially constructed on the amplifier strip. The outstanding feature of this switch is that "record" or "playback" operation of the Minifon is automatically selected by the insertion of either the microphone plug or the earset plug into a jack and switch combination. This combination consists of a jack containing five contact rings, which is set between two switches. Normally the switches are set for recording operation. During this operation only three of the rings come in contact with the microphone plug. In the playback cycle all rings come in contact with the longer earset plug. At the same time two plungers are operated by the longer plug to place the switches into playback position. This arrangement eliminates the need of additional operations and switching components thereby reducing to some extent, the possibilities of human error. (Note EXHIBITS VII, VIII, IX, XII).
- (c) *Volume Control*: A miniature volume control, measuring 3/4 inch in diameter, and a miniature output transformer are included in the amplifier strip. (See EXHIBIT IX).
- (3) *Power Supplies*: The recorder is completely portable and can be operated by self contained batteries or from 117 volts A.C. by the use of an external transformer power supply (for motor only).
- (a) *Batteries*: Normally the recorder is battery operated. The batteries consist of a standard 1-1/2 volts A battery of type similar to Burgess Z or Eveready Penlite, a standard 30 volt B battery of type similar to Burgess V20 or Eveready 413, and a special 8-3/4 volt motor battery. Seven Mallory RM-4Z cells, in series, comprise the motor battery. The motor battery is specified to be good for 24 hours of usage, while the service life of the A and B batteries is estimated to be 25 and 50 to 75 hours, respectively. (Note EXHIBITS I, V).
- (b) *A.C. Supply*: The recorder may be operated from 117 volts AC through the use of an auxiliary transformer and selenium rectifier power pack providing 9 volts D.C. This pack supplies power only to the motor and is plugged into a small receptacle located on the bottom left edge of the recorder case. (Note EXHIBITS II, XI).
- (4) *Accessories*: Additional equipments include the earset, microphone and leather carrying case. (See EXHIBIT I).
- (a) *Earset*: The headset used is of the hearing aid type, similar to the Telex Monoset, with a 600 ohm impedance unit.

## CONFIDENTIAL

- (b) *Microphone:* The microphone is a small, omni-directional, crystal diaphragm type having a high impedance characteristic.
- (5) *Operating Data:* The operation of the recorder is simple and may be broken down to three phases; namely "record", "playback" and "erase."

(a) *To Record:*

1. Check to make sure the wire is taut and securely fastened the take-up spool.
2. Be sure the transfer switch is in "IN" position (toward case).
3. Insert microphone firmly into jack.
4. Be sure the erase magnet is swung clear, away from the wire.
5. Pull out "on-off" switch to start the instrument. Speak into the microphone in a natural voice at distances up to three or four feet. Normal volume control setting is indicated by the alignment of two dots (one on the volume control, the other on the case). To turn off the recorder, simply push back the "on-off" switch.

(b) *To Playback:*

1. Remove the microphone and insert the earset.
2. Turn on recorder by pulling out "on-off" switch and immediately pull out (away from case) the transfer switch. This will cause the instrument to rewind. Rewind may be stopped at any point by depressing the transfer switch (towards case). The instrument is now in playback operation, and may be monitored through the headset. The volume control may be adjusted at any time. The recorder is turned off by depressing the "on-off" switch.

(c) *To Erase:*

1. Always erase during rewind cycle.
2. Slide the protruding stud of the erase magnet toward (to the right) the wire.
3. Start recorder by pulling out "on-off" switch. Pull out transfer switch to place the recorder into rewind. All sounds previously recorded will now be removed.
4. When the wire has been fully rewound, push in transfer switch, depress the main (on-off) switch and swing the erase head away (to the left) from the wire. The

## CONFIDENTIAL

recorder is now turned off and ready for a new recording.

- (6) *Theory of Operation:* The circuit operations of the Minifon are described as follows: (Note EXHIBIT XII).
- (a) *Recording Circuit Operation:* In the recording cycle, sound information is picked up by the microphone and brought to the control grid of the first tube, DF-67. From this tube the signal is further amplified by another stage, tube DF-67, and is then fed into the final amplifier tube DL-67. The volume control is in the input of the DL-67 stage and varies the gain of the amplifier through the use of a negative bias voltage. Tube DL-67 is also used to supply the signal information to the recording head. The signal information is then permanently applied to the moving wire.
- (b) *Playback Circuit Operation:* In this cycle the signal information, previously recorded on the wire, is picked up by the record-pickup head and fed into the input stage tube DF-67. The record-playback jack and switch arrangement, described earlier in this report, automatically places the recording head into the input stage of the amplifier when the earset is plugged in. At the same time, the output of the final amplifier, tube DL-67, is automatically connected to a subminiature output transformer which in turn, is connected to the earset. The output transformer has a nominal impedance of 500 ohms and is driven by the final amplifier DL-67. With the exception of the input and output changes just described, the signal path and amplifier operation remain the same as in the recording cycle.
- (c) *Erase Theory:* All recorded information is removed from the wire by a permanent magnet. This is accomplished by bringing the magnet into contact with the moving wire during rewind operation. The fixed field of the permanent magnet then erases the recorded information.

### b. Performance Characteristics of the Minifon Wire Recorder

The following performance data is described in accordance with the particular operating cycle in use. The information deals primarily with the practical limitations of frequency response and gain parameters established by earlier spot tests of the performance of the Minifon. With the exception of power consumption data, all test readings in this report were taken on a voltage basis. A series resistor of 15 thousand ohms was inserted between the multiplier output attenuator of the Hewlett-Packard audio generator model hp-650A and the input of the Minifon to minimize any loading effects of the generator. Other test equipments, consisting of a Hewlett-Packard V.T.V.M., model hp-410B; Hewlett-Packard V.T.V.M., model hp 400A and oscilloscope, Sylvania, model 112A used directly at points of test, introduced negligible shunt effects because of their high input impedances.



## CONFIDENTIAL

Gain versus frequency response measurements were taken with the volume control at normal or average setting for frequencies above 100 cycles. Normal volume setting is indicated by the alignment of two black dots; one on the volume control and the other alongside on the plastic case. This setting was decided upon because of the extremely poor response of the recorder below 100 cycles which resulted in unreliable and inconsistent readings; also because of the distortion and excessive noise present with the gain control in the wide open position. One series of tests was conducted to determine the performance of the amplifier with the volume control at maximum gain setting. All bandwidth figures are given at 6 db down from maximum in the gain output versus frequency measurements.

(1) *Gain Versus Frequency Response Data:* The following paragraphs describe the gain versus frequency response characteristics of the Minifon during (a) recording, (b) playback and (c) overall (combined recording and playback on wire) operations. Paragraph (d) describes the maximum gain features of the recorder amplifier. Optimum input signal level lies between approximately 1 to 20 millivolts. Below 1 millivolt input the excessive background and residual noise factors resulted in extremely poor overall recorder performance. Inputs above 20 millivolts introduced excessive distortion of the signal waveforms. An input signal of 7 millivolts was used in the following tests under paragraphs (a), (b) and (c) below.

(a) *Gain Versus Frequency Data During Recording:* In this test the volume control was adjusted for normal gain (two dots aligned) and the recording wire was removed. The audio signal generator hp 650A was connected to the input grid of the first stage of the amplifier through a 15 thousand ohm resistor and the output was measured and monitored at the plate of the final amplifier by V.T.V.M. and oscilloscope. The following table represents the gain versus frequency characteristics of the amplifier in this operation. (Note Curve A, EXHIBIT XIII).

Frequency (Cycle)	db Gain
100	32.7
200	41.4
300	46.0
500	49.8
1000	54.7
2000	50.2
3000	52.0

CONFIDENTIAL

Frequency (Cycle)	db Gain
4000	61.0
5000	59.0
6000	57.7
8000	55.1
9000	54.0
10,000	53.2

During the recording cycle the amplifier provided a maximum gain of 62 db at 3000 cycles with a bandwidth (6 db points) of 6000 cycles.

- (b) *Gain Versus Frequency Data During Playback:* The conditions of this test were similar to those in the recording tests, with the exception that the final amplifier stage was connected to the output transformer. The table below lists the gain versus frequency figures of the amplifier in playback. (Note Curve B, EXHIBIT XIII).

Frequency (Cycles)	db Gain
60	31.1
100	38.3
200	47.1
300	50.4
500	55.4
1000	62.5
1300	63.7
2000	60.7
3000	56.5
4000	53.1
5000	51.4
6000	49.9
7000	48.4
8000	47.6
10,000	45.3
12,000	44.0

CONFIDENTIAL

In the playback phase the amplifier provided a maximum gain of 63.7 db at 1300 cycles with a bandwidth of 2300 cycles.

- (c) *Overall Gain Versus Frequency of Recorder:* In this test actual recordings were made on the wire and played back through the record-pickup head. The signal was fed into the amplifier in the same manner as in the previous tests with the volume control set for normal gain. In playback however, the recorded information was picked up by the head and fed back into the amplifier. Measurements were taken at the plate of the final amplifier during playback. The following data represents the overall gain versus frequency performance of the Minifon in actual usage with the same level of signal input established in the previous tests. (Note Curve C, EXHIBIT XIII).

Frequency (Cycles)	db Gain
100	30.8
200	33.7
300	36.0
500	38.8
1000	40.5
2000	35.2
3000	33.6
4000	29.6
5000 to 8000	Signal audible and discernable on oscilloscope; unreliable readings on V.T.V.M.
9000 to 10,000	Signal inaudible and not discernable on oscilloscope.

The overall gain versus frequency performance of the Minifon indicated a maximum gain of 40.5 db at 1000 cycles with a bandwidth of approximately 2150 cycles.

To keep all test data on a comparable basis the same signal input levels were maintained in tests described in the above paragraphs. However, complete readings to 10,000 cycles for overall response of the recorder can be obtained, by increasing the signal input to the instrument.

- (d) *Maximum Gain Versus Frequency Response of the Amplifier Alone:* Tests were also performed to determine the maximum gain and bandwidth characteristics of the recorder amplifier. The

## CONFIDENTIAL

conditions of these tests were similar to those described under recording tests, paragraph (a) above, except that the volume control was at maximum gain setting and the signal input was kept at 1 millivolt. The following table lists data obtained.

Frequency (Cycle)	db Gain
100	41.1
200	54.0
300	57.0
500	65.3
1000	70.5
3000	80.5
4000	80.7
6000	78.4
8000	75.5
10,000	74.0
12,000	72.7

The maximum gain of the amplifier is 80.7 db at 4,000 cycles. The bandwidth (6 db down) is approximately 7,000 cycles. No response curve of this test is shown in this report because of its similarity to that of Curve A in EXHIBIT XIII.

- (2) **Erase and Noise Data:** The permanent magnet erase unit incorporated into the Minifom satisfies normal erasure requirements. However, test results obtained after erasure indicated relatively high levels of residual noise on the wire.

Tests were performed to determine the approximate overall noise characteristics of the recorder and were made on the basis of a 2 to 1 voltage ratio of signal-plus-noise to noise measured at the output. This represents a condition of equality between signal and noise as measured on a peak basis. Data was taken at spot frequencies and the volume control was set at maximum gain position. A reading was taken of the recorder's output after the wire had been erased. A signal, consisting of a fixed frequency audio note, was then injected into the recorder, and the level adjusted, to give twice the aforementioned reading. The following table lists required signal input in millivolts, to meet the conditions described above.

CONFIDENTIAL

Frequency in cycles	Input Voltage (For 2:1 Signal - plus-noise to noise output)
1000	.25 millivolts
3000	.14 "
5000	.30 "
10,000	.52 "

(3) *Motor and Wire Speed Data:* Tests were made to determine the effects on wire feed rate due to variations of input voltages to the motor. The number of revolutions of the take-up reel was recorded for different values of input voltages to the motor. The rotational rate of the take-up reel was slow enough to be measured by stop watch technique. Data for this test is listed below.

Input Voltage to Motor (Under Load)	Revolutions per minute
14.2	60
10.8	57
8.75	57
8.2	57
7.1	54
6.0	54
5.2	54
5.0	45

All tests, described earlier in this report, were conducted with input voltages to the motor in the order of 8.0 to 8.5 volts D.C. This provided a measured wire feed rate of 9 to 10 inches per second.

(4) *Power Consumption Data:* The measured power consumption of the Minifon, using batteries, was as follows:

- (a) The filament power consumption totalled .044 watts, at 1.38 volts and .032 amperes.
- (b) The high voltage (E+) power consumption totalled .012 watt, at 30 volts and .0004 amperes.
- (c) The power consumption of the motor totalled .57 watts. The battery voltage was 8.2 volts and current drawn was .07 ampere.

5. **CONCLUSIONS:**

Throughout the tests, the Minifon proved reliable and trouble free. At no

## CONFIDENTIAL

time were tests delayed to correct any component failure. The instrument is neatly and compactly assembled. Battery replacement, exchange of the wire spools, and other phases of general operation of the recorder, were convenient and simple. The various sections of the recorder are removable for examination and repairs. The small size, lightweight and complete independence of external power needs make the recorder completely containable within the average briefcase. The plastic case and wire transport system are sufficiently rugged to survive average treatment. It is doubtful if the instrument, as presently constructed, could survive minimum shock or vibration tests required for military usage.

Electrically the Minifon performed satisfactorily. The overall sensitivity was adequate and bandwidth was sufficient for normal voice reproduction. The power requirements for the unit were favorable.

The stability of the motor and drive assembly could be improved, however. Variations in wire feed rate between record and playback phases were noticed. These variations became quite severe after 2 or more hours. Background noises picked up by the microphone was considered quite high. The rewind speed and lack of an arrangement to indicate wire footage, made monitoring of the recordings tedious and power consuming.

The outstanding characteristics of the Minifon remain size and weight; and these physical characteristics make it adaptable to many applications requiring a high degree of portability. For voice reproductions the instrument functioned satisfactorily and proved to be quite dependable.

### 6. RECOMMENDATIONS:

To further improve the Minifon, and in particular, to modify it to meet minimum countermeasures military requirements, it is recommended that:

a. The design and construction be improved to meet JAN specifications and military environmental conditions, within limits of present size and weight.

b. The overall frequency response of the recorder be extended to provide a minimum bandwidth of 10,000 cycles.

c. In order of importance, a wire footage indicator, improved erase facilities, and automatic gain control circuit be included. For precision timing purposes; it would also be desirable to provide calibration facilities.

d. The possibility of further reduction of size and weight of the Minifon be investigated. Such investigation should also include the possibilities of replacing amplifier tubes with transistors and the use of printed circuit techniques in fabricating the amplifier.

### 7. ACKNOWLEDGMENT:

Acknowledgment is made of the efforts of John Vitola and Julius Bizzaso for their contributions and assistance in the compilation of data for this report.

CONFIDENTIAL

8. REFERENCES:

- a. "Operating Manual" for Minifon Wire Recorder
- b. "A New Pocket Wire Recorder"; Audio Engineering Society Journal; January 1953, by O. Read.

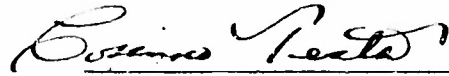

COSIMO TESTA  
Engineer, Radio

Approved by:



HERBERT BUTLER  
Chief, Data Processing Section, ESL

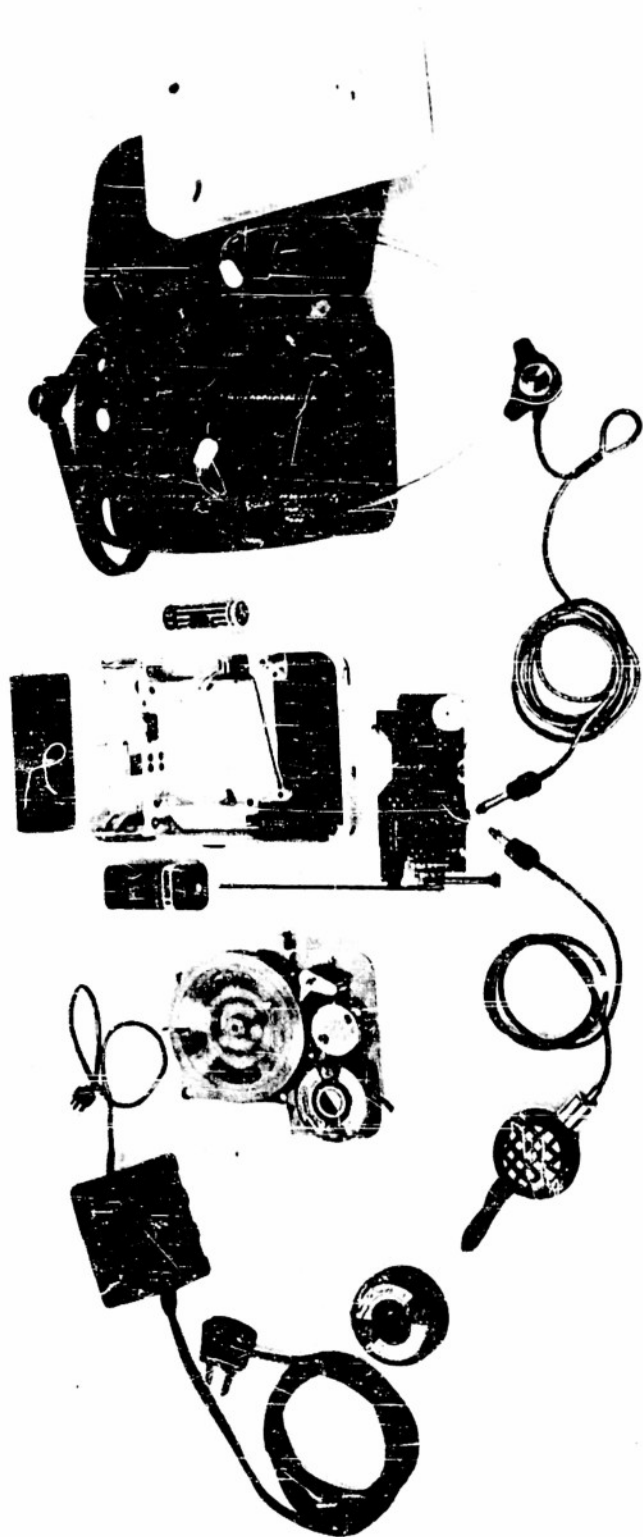

EXHIBIT I

MINIFON WIRE RECORDER . (German) . (Standard) . Project 1119-A  
Mfr. Minifon Corp . Dist'r. Robt. Halmage Co. Inc.; Newark, N. J.  
Display View . Showing Complete Unit Un-Assembled

DATE 5-12-54

SIGNAL CORPS ENGINEERING LABORATORIES

NO. SCSEL 39283



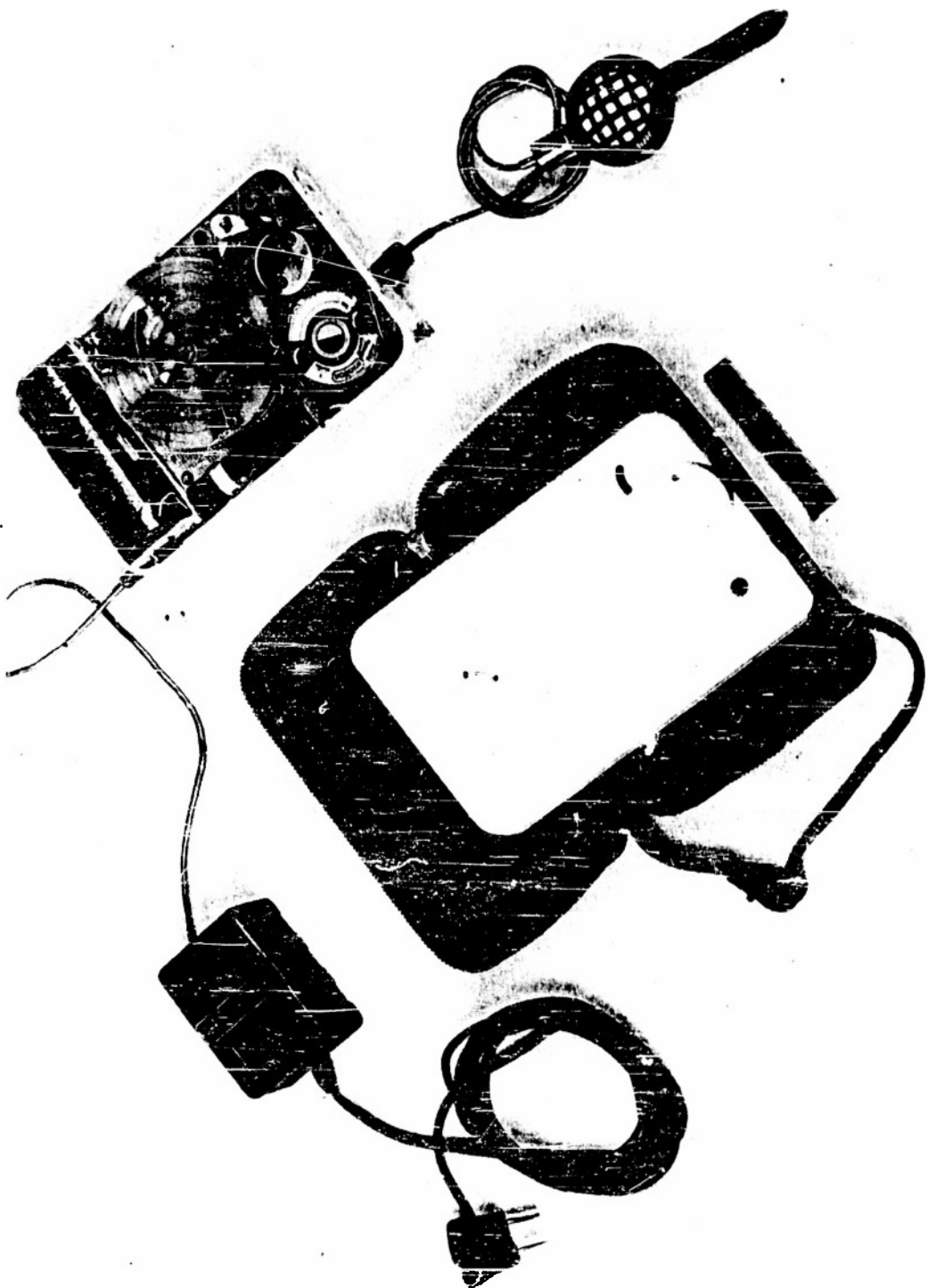

MINIFON WIRE RECORDER . (German) . (Standard) . Project 1119-A  
Mfr. Minifon Corp . Dist'r. Robt. Halimage Co. Inc., Newark, N. J.  
Group View . RECORD ASSEMBLY . Showing Microphone Plug Inserted for Recording,  
and Power Unit Inserted for AC Operation of Motor

DATE 5-12-54

SIGNAL CORPS ENGINEERING LABORATORIES

NO SC&L 39281

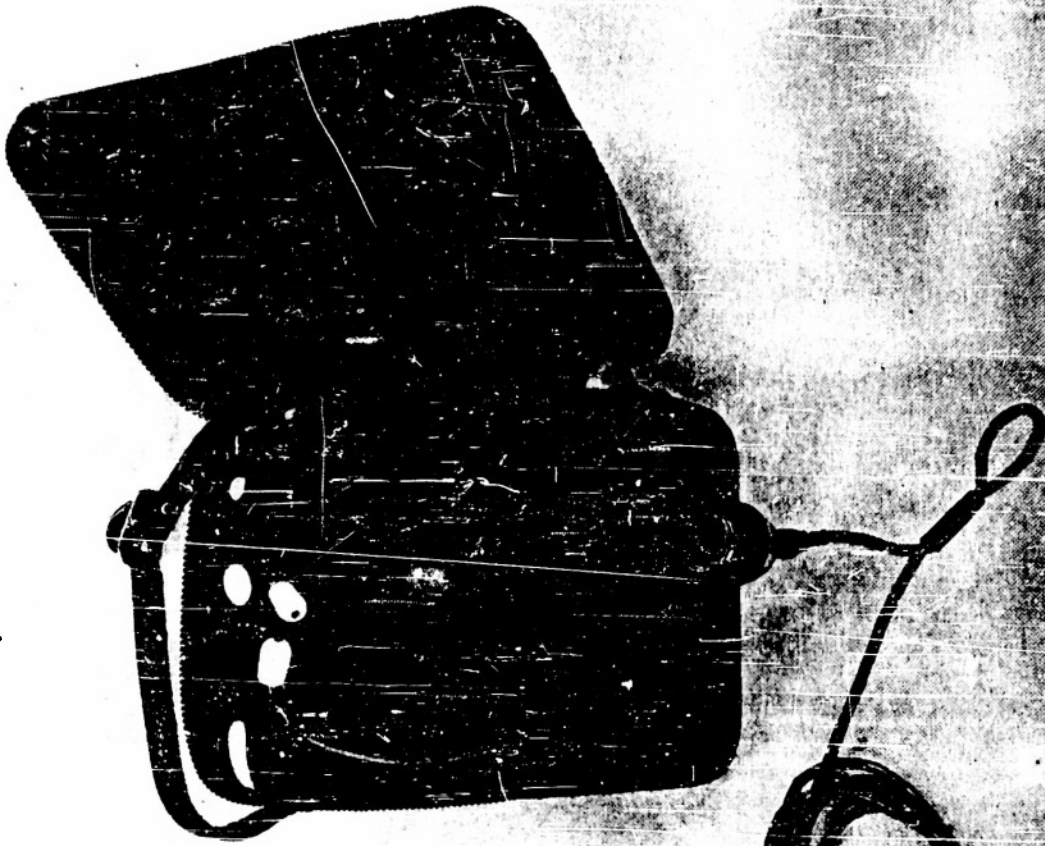
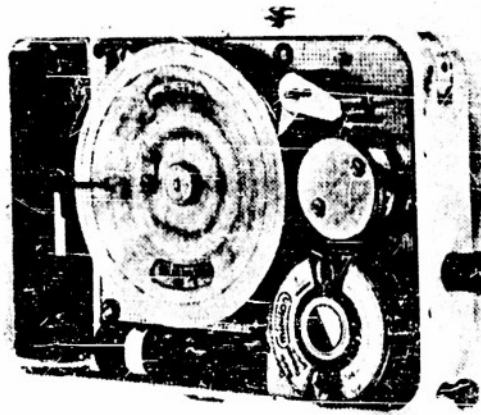

EXHIBIT III

MINIFON WIRE RECORDER . (German) . (Standard) . Project 1119-A  
Mfr. Minifon Corp . Dist'r. Robt. Halmege Co. Inc., Newark, N. J.  
Group View . PLAYBACK ASSEMBLY . Showing Head-Set Plug Inserted for Playback Operation,  
also Zipper Carrying Case

DATE 5-12-54

SIGNAL CORPS ENGINEERING LABORATORIES

NO. SCCL 39282

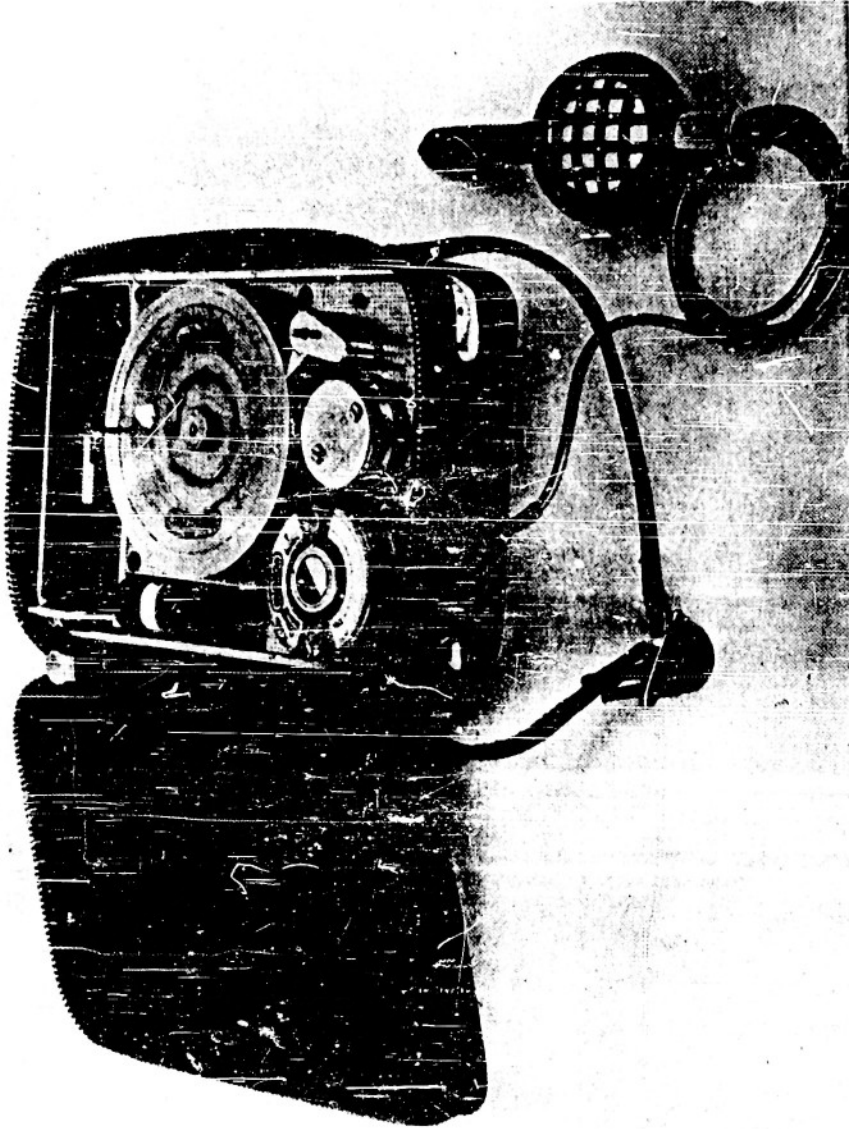

MINIFON WIRE RECORDER . (German) . (Standard) . Project 1119-A  
Mfr. Minifon Corp . Dist'r. Robt. Halvage Co. Inc., Newark, N. J.  
Overall View . RECEIVING OPERATION . Showing Unit in Carrying Case, Cover Raised,  
with Microphone Inserted Ready for Recording

DATE 5-12-54

SIGNAL CORPS ENGINEERING LABORATORIES

NO 116EL 39288

EXHIBIT IV

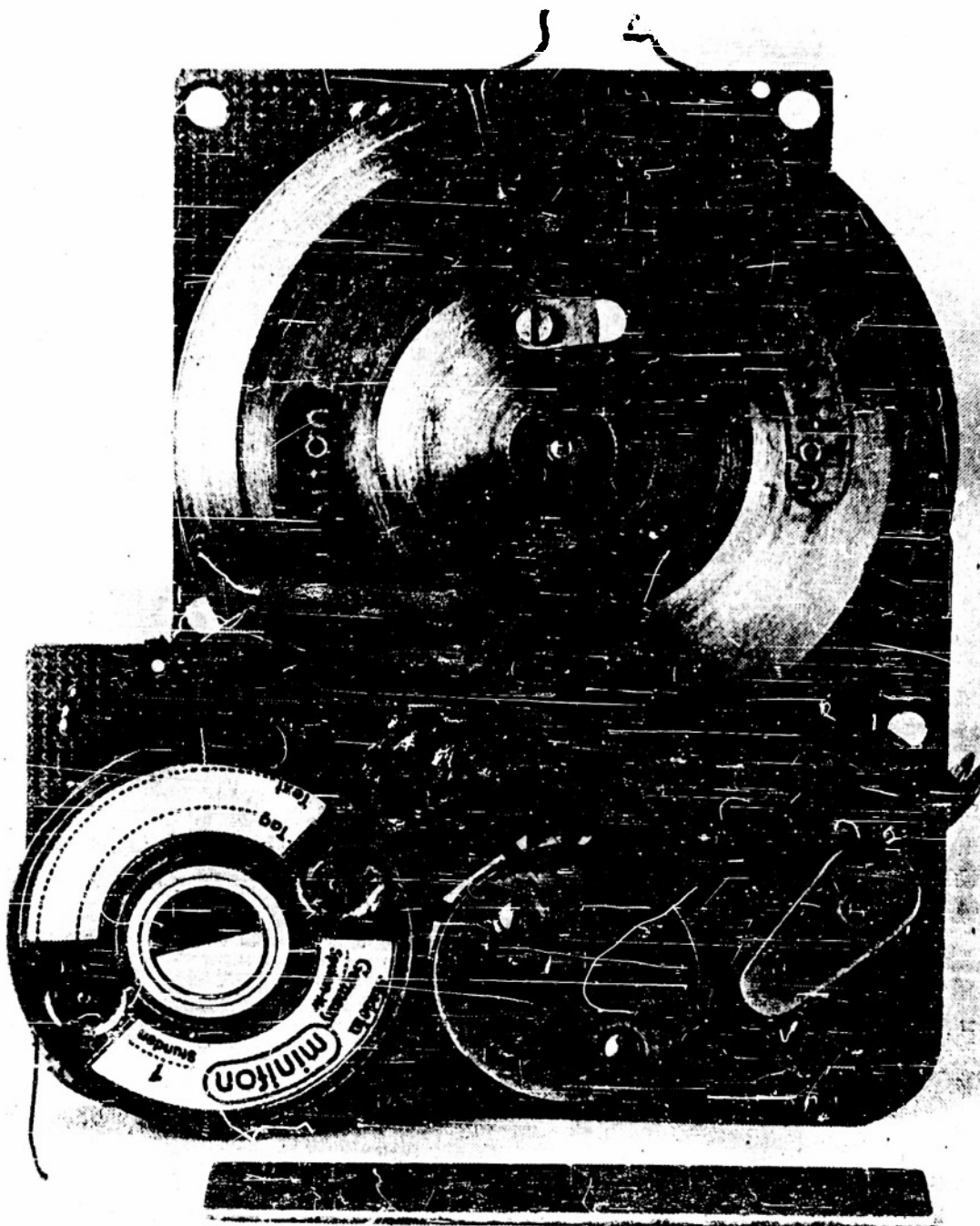

MINIFON WIRE RECORDER . (German) . (Standard) . Project 1119-A  
Mfr. Minifon Corp . Dist'r. Robt. Halmage Co, Inc., Newark, N. J.  
Close-up Top View . WIRE FEED MECHANISM . Showing Construction Details

DATE 5-12-54

SIGNAL CORPS ENGINEERING LABORATORIES

NO SCEL 39289

EXHIBIT V

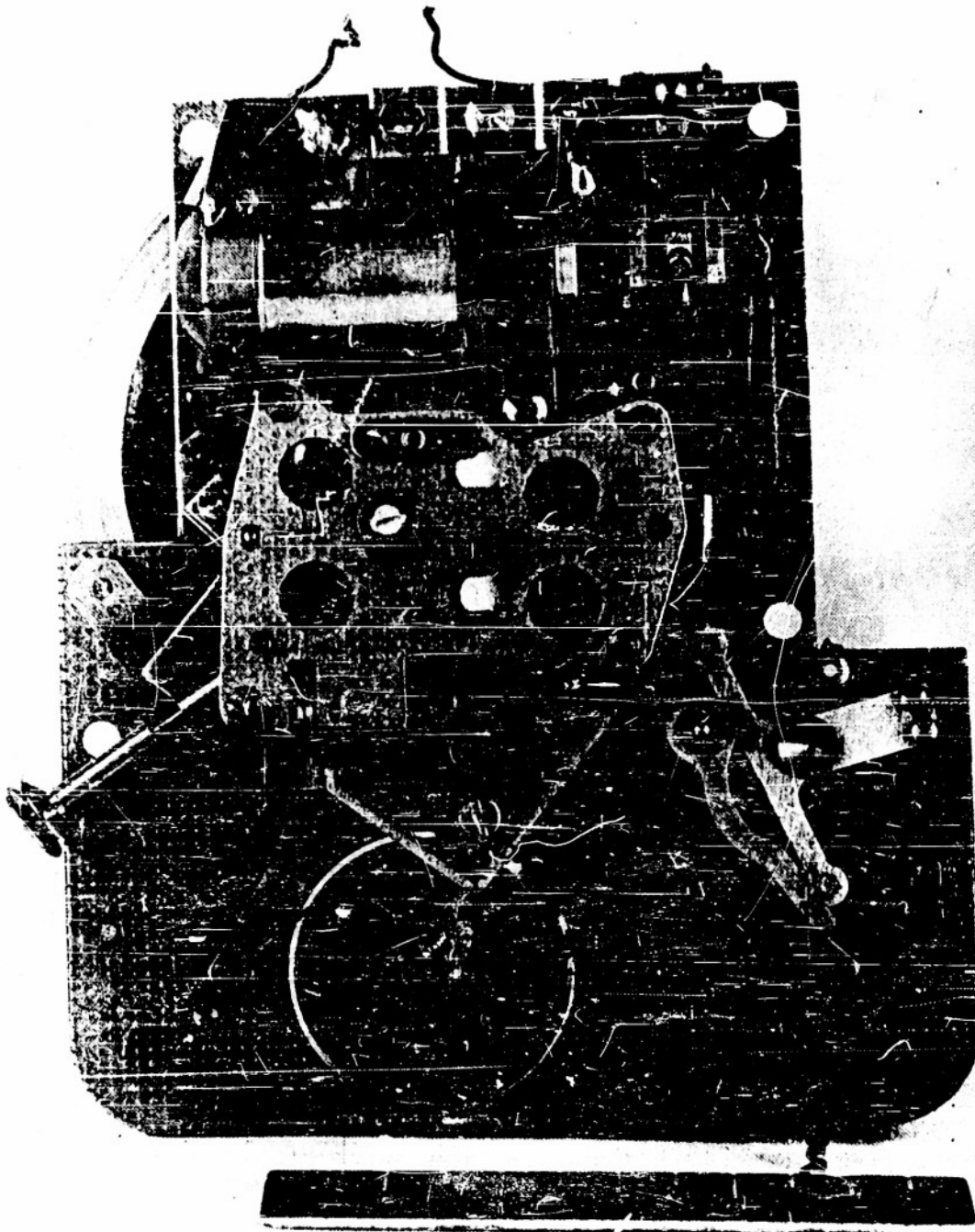

MINIFON WIRE RECORDER . (German) . (Standard) . Project 1119-A  
Mfr. Minifon Corp . Dist'r, Robt. Halmage Co, Inc., Newark, N. J.  
Close-up Bottom View . WIRE FEED MECHANISM . Showing Construction Details

DATE 5-12-54

SIGNAL CORPS ENGINEERING LABORATORIES

NO SC439290

EXHIBIT VI

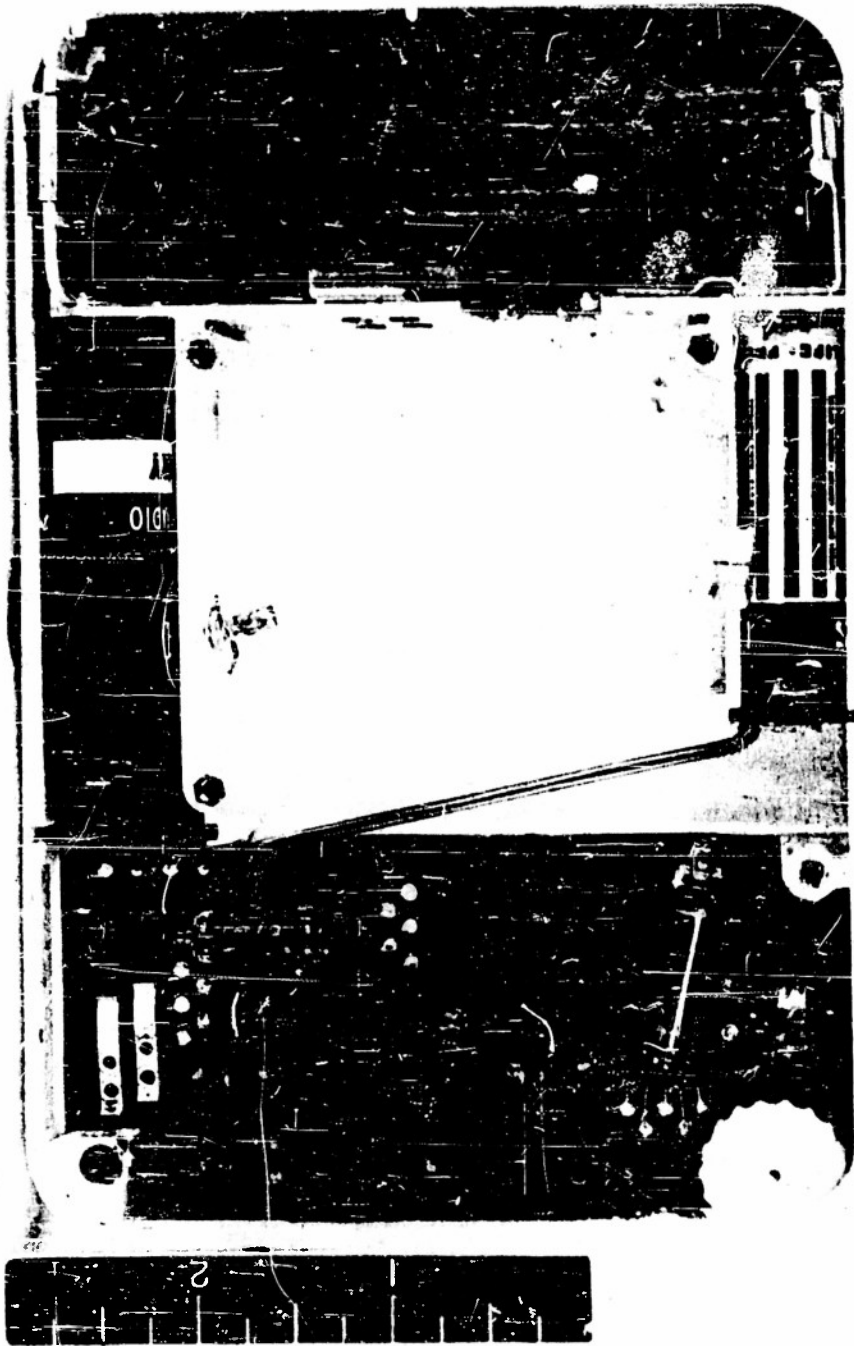

MINIFON WIRE RECORDER . (German) . (Standard) . Project 1119-A  
Mfr. Minifon Corp . Dist'r. Robt. Halpage Co. Inc., Newark, N. J.  
Overall View . Showing Plastic Case, Cover Removed, with Amplifier and Batteries in Place

EXHIBIT VII

DATE 5-12-54

SIGNAL CORPS ENGINEERING LABORATORIES

NO SCAL 39286

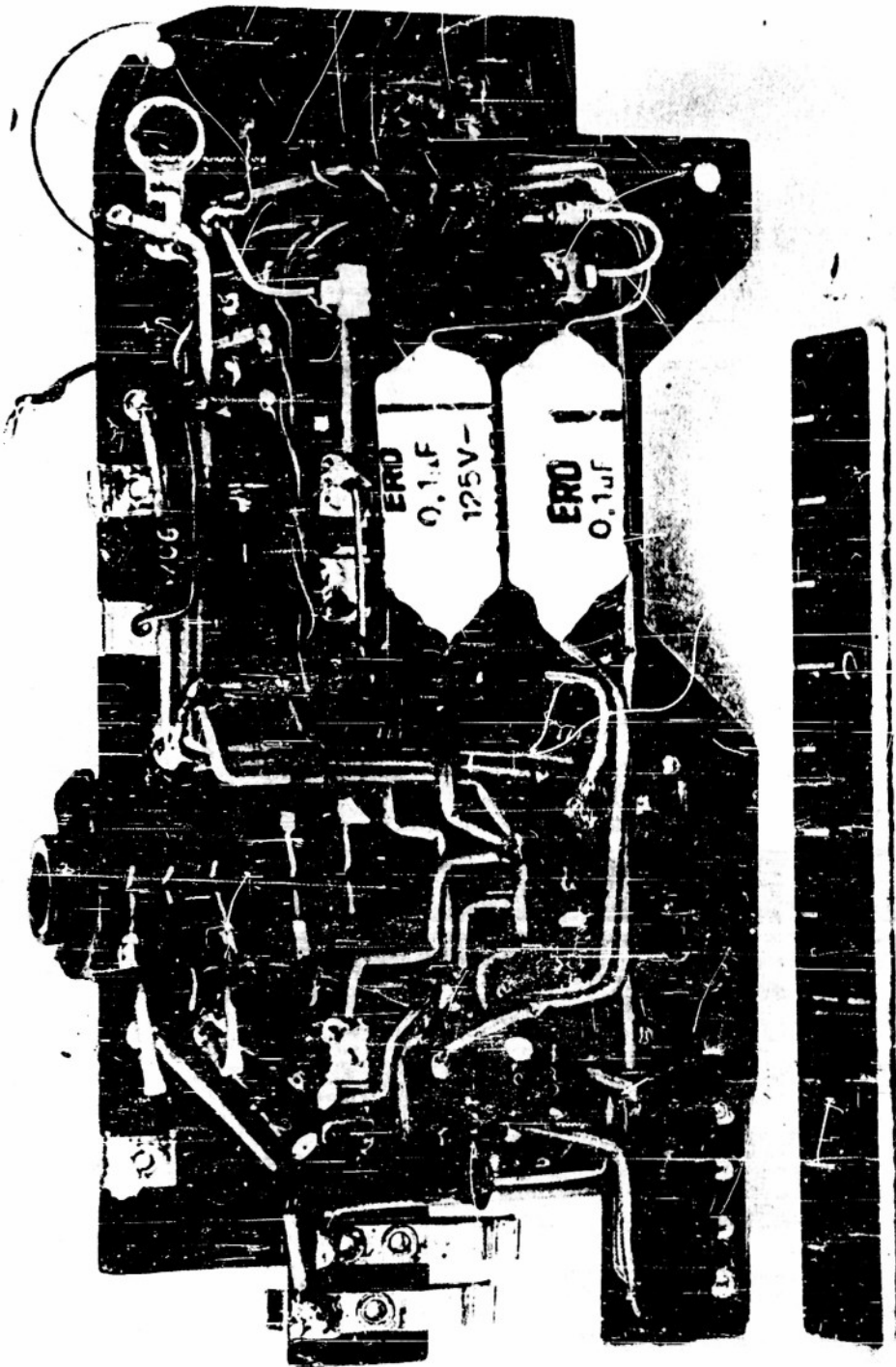

EXHIBIT VIII

MINIFON WIRE RECORDER . (German) . (Standard) . Project 1119-A  
Mfr. Minifon Corp . Dist'r. Robt. Balmage Co. Inc., Newark, N. J.  
Close-up Bottom View . AMPLIFIER STRIP . Showing Wiring and Component Arrangement

DATE 5-12-54

SIGNAL CORPS ENGINEERING LABORATORIES

NO. S&EL 39285



MINIFON WIRE RECORDER . (German) . (Standard) . Project 1119-A  
Mfr. Minifon Corp . Dist'r. Robt. Kalmage Co. Inc., Newark, N. J.  
Close-up Top View . AMPLIFIER STRIP . Showing Tubes, Volume Control, Output Transformer,  
and Record-Playback Transfer Switch

NO. SCCL 39284

SIGNAL CORPS ENGINEERING LABORATORIES

DATE 5-12-54

1119-A-111



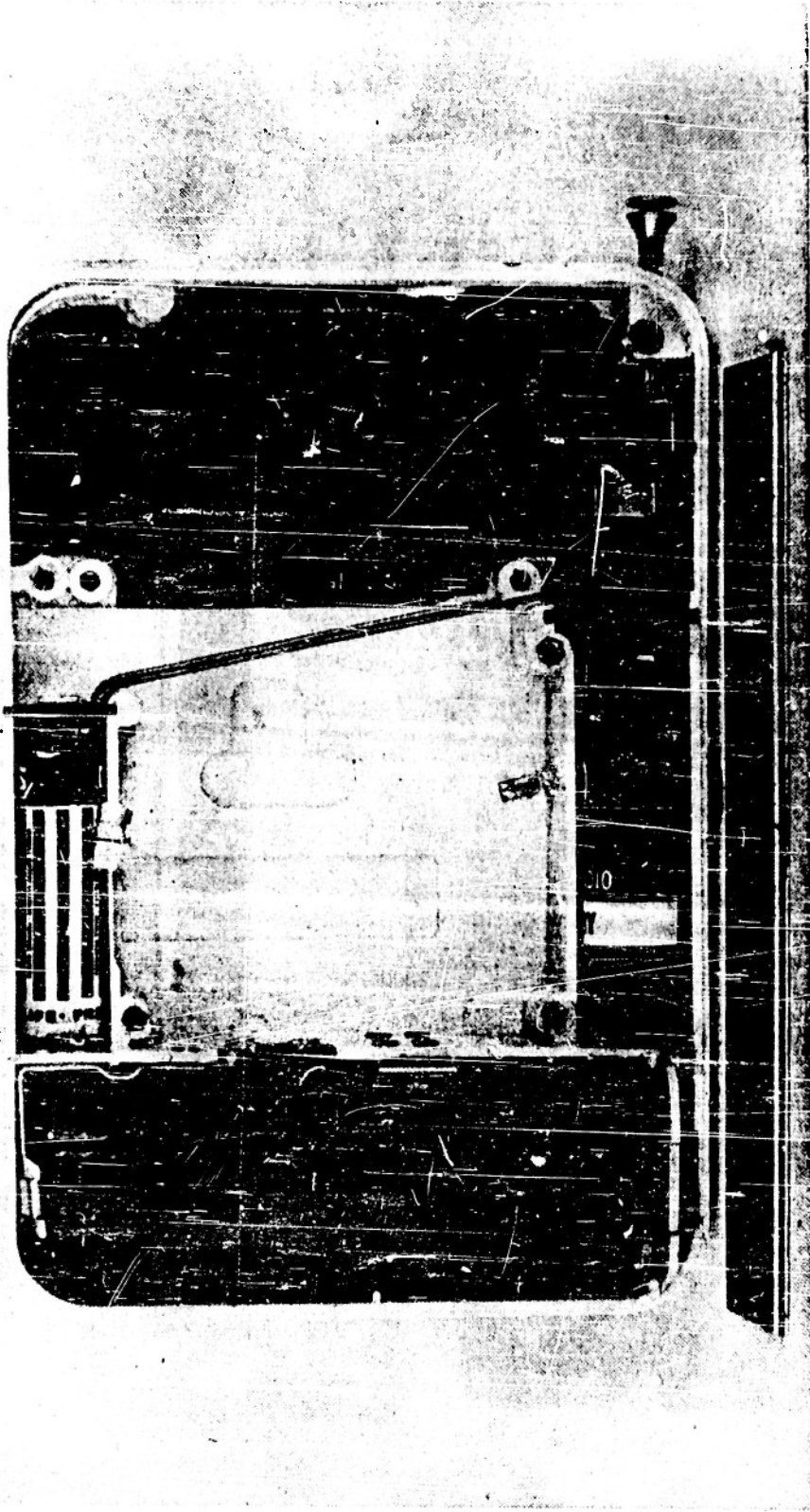

MINIFON WIRE RECORDER . (German) . (Standard) . Project 1119-A  
Mfr. Minifon Corp . Dist'r. Robt. Halmag Co. Inc., Newark, N. J.  
Overall View . Showing Plastic Case with Amplifier and Wire Transport Mechanism Removed  
and Showing Shielding and Batteries in Place

DATE 5-12-54

SIGNAL CORPS ENGINEERING LABORATORIES

NO. SCAL 39287

EXHIBIT X

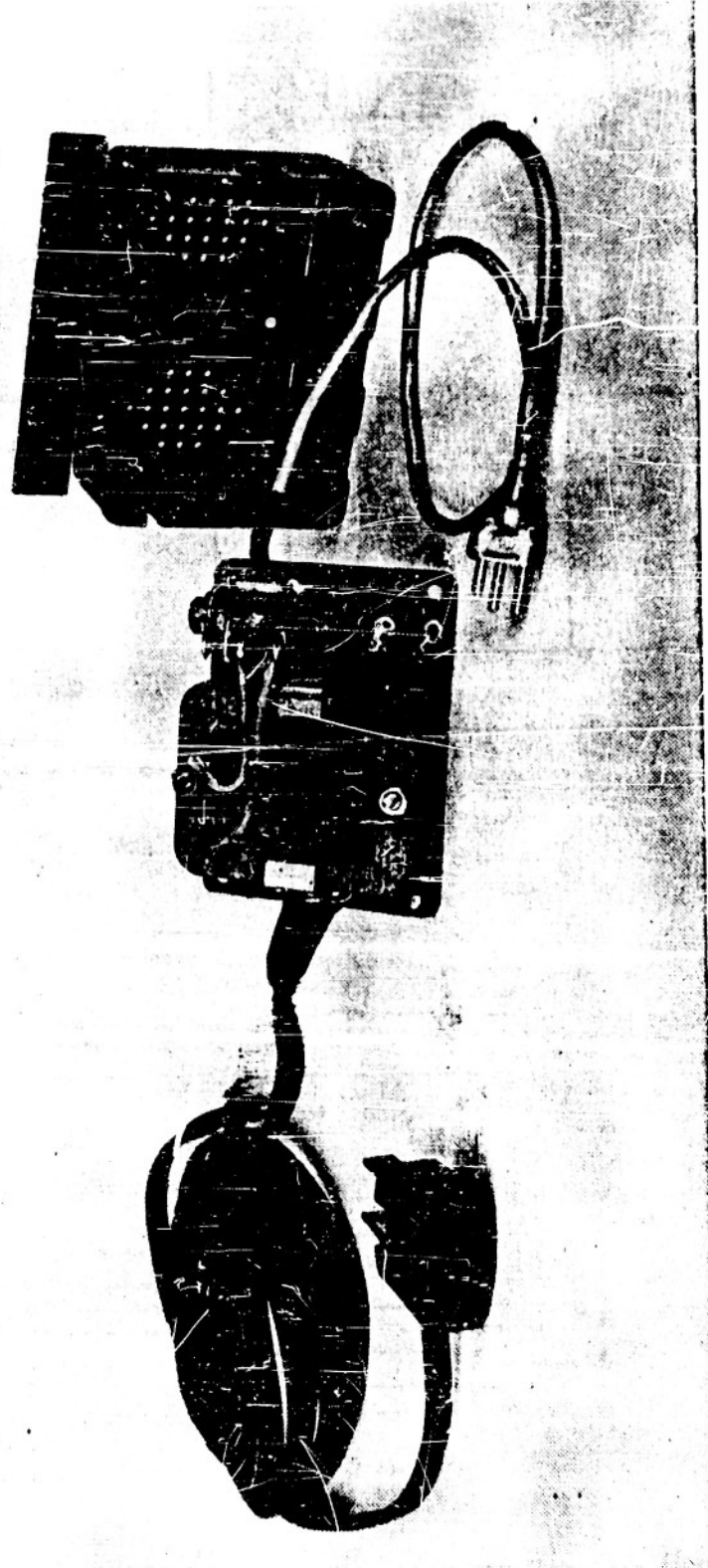

EXHIBIT XI

MINIFON WIRE RECORDER . (German) . (Standard) . Project 1119-A  
Mfr. Minifon Corp . Dist'r. Robt. Halmege Co. Inc., Newark, N. J.  
Group View . AC POWER SUPPLY FOR MOTOR DRIVE • Showing Step-down Transformer,  
Selenium Rectifier, and Cover

DATE 5-12-54

SIGNAL CORPS ENGINEERING LABORATORIES

NO SKVL 39291

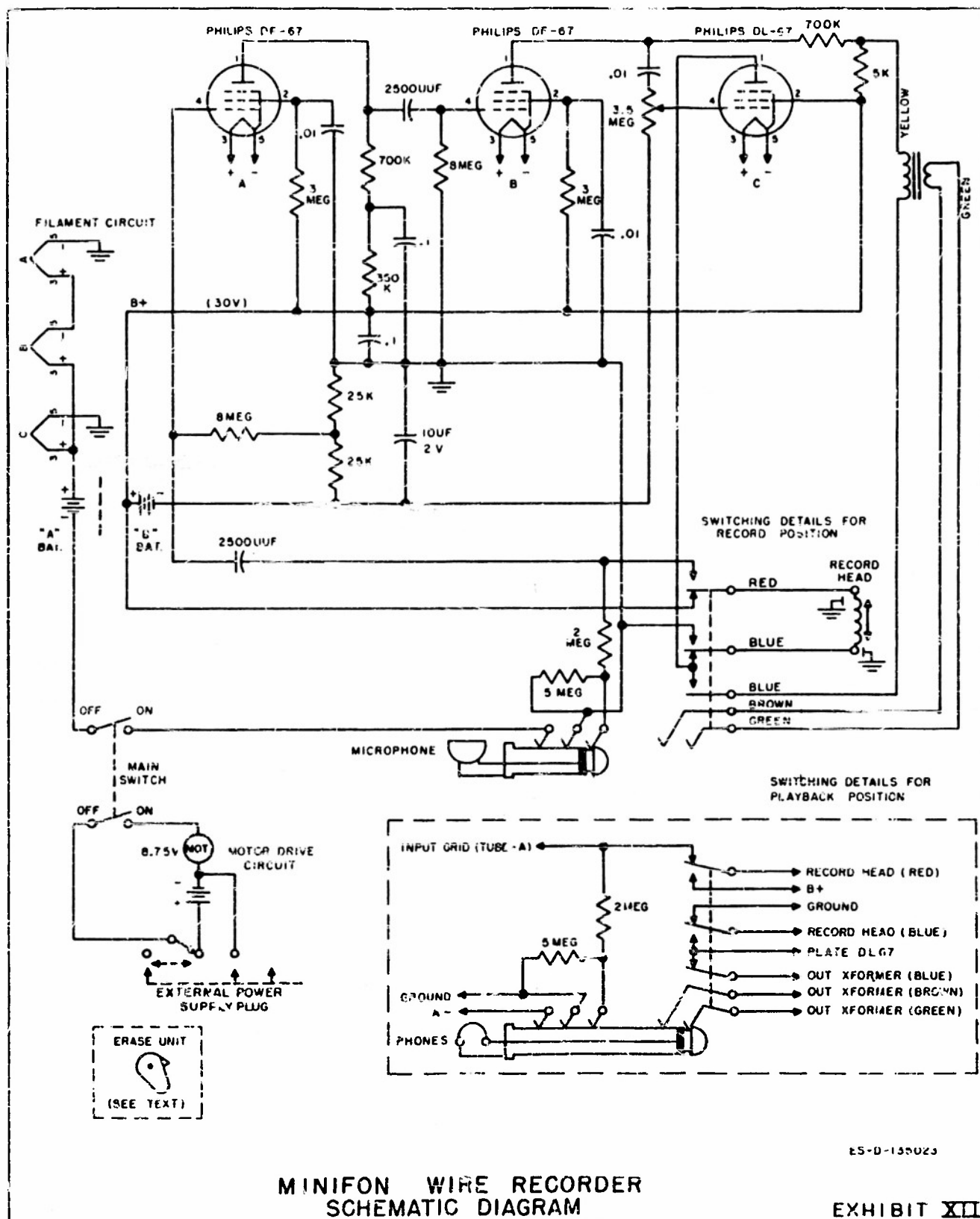

ES-D-135023

**MINIFON WIRE RECORDER  
SCHEMATIC DIAGRAM**

**EXHIBIT XII**

# GAIN VS FREQUENCY RESPONSE CURVES OF MINIFON WIRE RECORDER

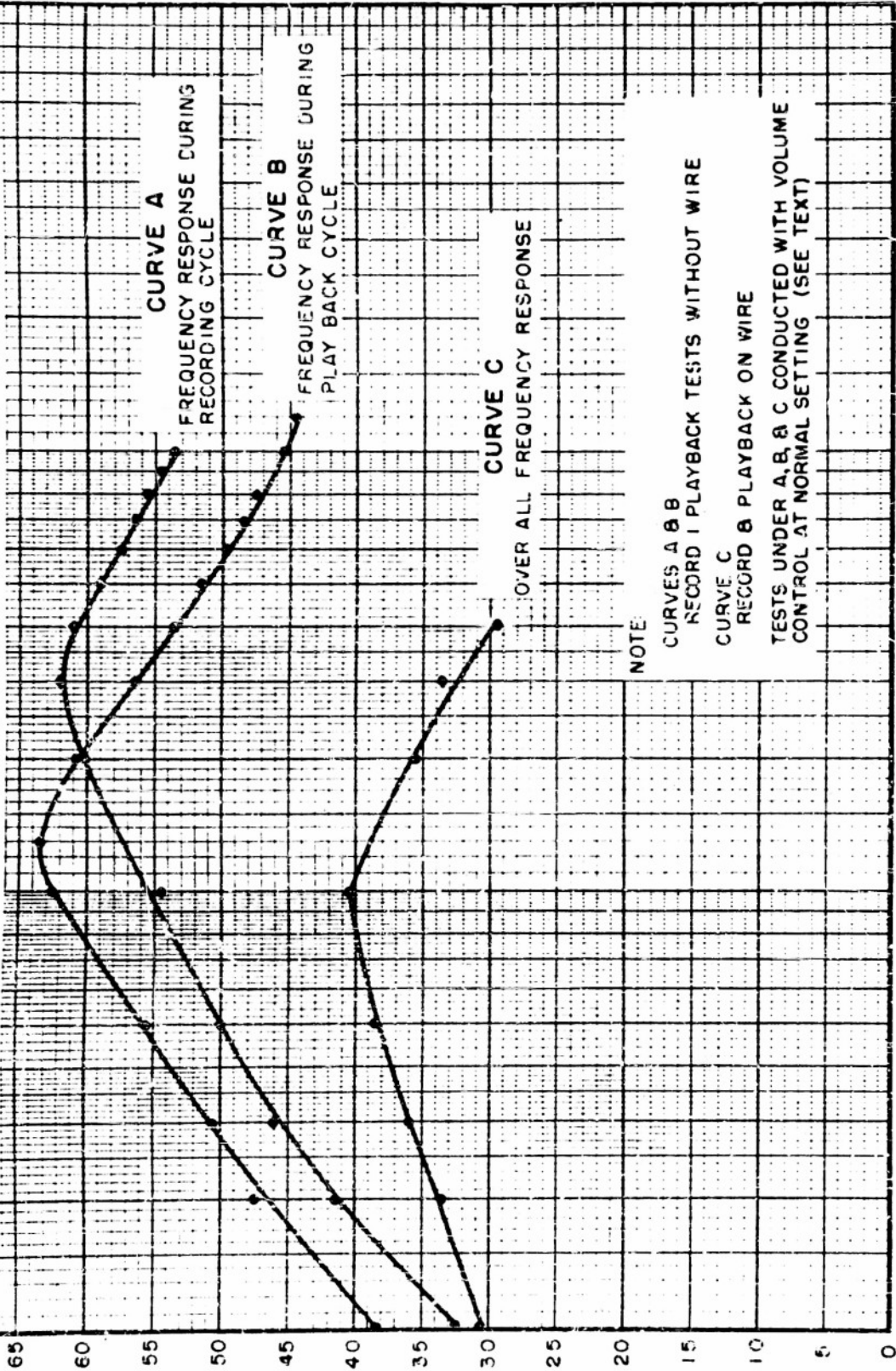

NOTE

- CURVES A & B  
RECORD & PLAYBACK TESTS WITHOUT WIRE
- CURVE C  
RECORD & PLAYBACK ON WIRE
- TESTS UNDER A, B, & C CONDUCTED WITH VOLUME CONTROL AT NORMAL SETTING (SEE TEXT)

# Armed Services Technical Information Agency

Because of our limited supply, you are requested to return this copy WHEN IT HAS SERVED YOUR PURPOSE so that it may be made available to other requesters. Your cooperation will be appreciated.

# AD

# 44780

NOTICE: WHEN GOVERNMENT OR OTHER DRAWINGS, SPECIFICATIONS OR OTHER DATA ARE USED FOR ANY PURPOSE OTHER THAN IN CONNECTION WITH A DEFINITELY RELATED GOVERNMENT PROCUREMENT OPERATION, THE U. S. GOVERNMENT THEREBY INCURS NO RESPONSIBILITY, NOR ANY OBLIGATION WHATSOEVER; AND THE FACT THAT THE GOVERNMENT MAY HAVE FORMULATED, FURNISHED, OR IN ANY WAY SUPPLIED THE SAID DRAWINGS, SPECIFICATIONS, OR OTHER DATA IS NOT TO BE REGARDED BY IMPLICATION OR OTHERWISE AS IN ANY MANNER LICENSING THE HOLDER OR ANY OTHER PERSON OR CORPORATION, OR CONVEYING ANY RIGHTS OR PERMISSION TO MANUFACTURE, USE OR SELL ANY PATENTED INVENTION THAT MAY IN ANY WAY BE RELATED THERETO.

Reproduced by  
**DOCUMENT SERVICE CENTER**  
WATT BUILDING, DAYTON, 2, OHIO